

Best Quality

Best Prices

Access Control & Fencing Products



**Save Money!
Buy Direct!**

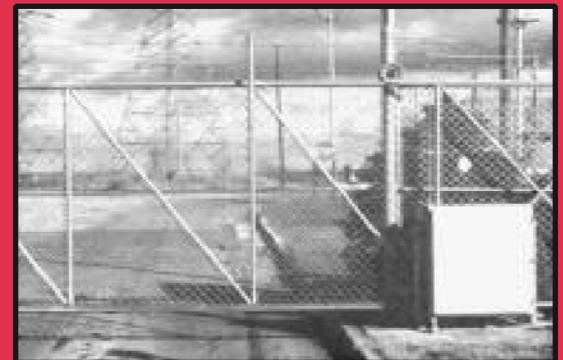

**Nationwide
Warehouses
Most Items
Next Day
Shipping**

(800) 733-7422

(763) 425-9000

(763) 425-9006 Fax

www.ispfence.com

**International
Security
Products**



International Security Products (ISP) is your one-stop source for all your fencing needs. We can supply you with the materials you require to install our products yourself. We can also offer you complete installation services for any project, large or small.

With more than 20 years of experience, ISP knows fencing. Whether you have a specialized need for a unique product or need the best price possible for a large chain link project, think of ISP first. ISP features same-day quotation on most projects. Our prices are competitive and we provide timely and cost-effective shipping from more than 50 locations across the nation. Fax us a drawing of your project or call us with details. We'll do the rest.

Among our extensive product lines, you will find the best available materials and workmanship in the following categories:

- Galvanized, aluminized and vinyl coated chain link fence and fittings in all sizes and gauges (Government specification material also available.)
- A complete line of vinyl, ornamental aluminum and ornamental steel fence products
- Custom commercial and residential swing gates, walk gates, double-drive gates and cantilever sliding gates
- A wide variety of automatic gate operators for residential and commercial applications
- Full Height and Waist - high security turnstiles

As with any dynamic business, International Security Products adds new products and services on a regular basis. If you don't see precisely what you need within this catalog, please call or fax. We'd be happy to assist you in any way we can.

Sincerely,

*Mike Bistodeau
President & CEO*

January 2005
(800) 733-7422 ◆ **(763) 425-9000** ◆ **FAX: (763) 425-9006**
www.ispfence.com

★ All prices are subject to change ★

swing gate operators

Swing Gate Operator — Light Duty



This system operates on 115 Volt AC - no special wiring required.

The system is designed and tested to work with the most rugged weather conditions in mind. Each system includes one radio receiver, two radio transmitters and master/slave capability.

Comfort • Security • Affordability • Status

For single gates up to 17' wide / 500 lbs.

SWR-211 without radio control
SWR-RC-211 with radio control (includes: 2 transmitters)
(Double Gates - Please Inquire)

1/2 hp – 115V– 1 Phase
Adjustable Limit Switches
Radio Control
* Available in 230v

Swing Gate Operator — Heavy Duty

This is the most versatile and rugged swing gate operator available today.

It is available in all voltages and is rated for continuous duty. A 3-button design controls open, close and stop. The system is factory pre-wired for easy installation. Master/slave capability is built in.



1 hp for single gates up to 19' wide / 1000 lbs.

Model SWC-111

1/2 hp for single gates up to 17' wide / 600 lbs.

Model SWC-211

See page 4 for accessories

International Security Products recommends the use of an electric safety edge or photoelectric control for pedestrian protection on all automatic or remotely controlled gate or door operators

(800) 733-7422

slide gate operators

Commercial Slide Gate Operator



Affordable Enhancement To Your Security System

1/2 hp for single gates up to 30' wide / 800 lbs.

Model SLR-211

Add for remote control

Security fencing will not be totally secure unless you block that hole in your fence with a gate operator.

This residential slide gate operator can be easily integrated into your overall security system.

The system includes

- All weather cabinet
- Keylock cable disconnect
- Magnetic disc brake to prevent coasting of gate
- Available in 115 or 230 Volts AC
- Factory prewired single button control
- Manual disconnect in case of power failure
- Master/slave capacity built in

Heavy Duty Slide Gate Operator

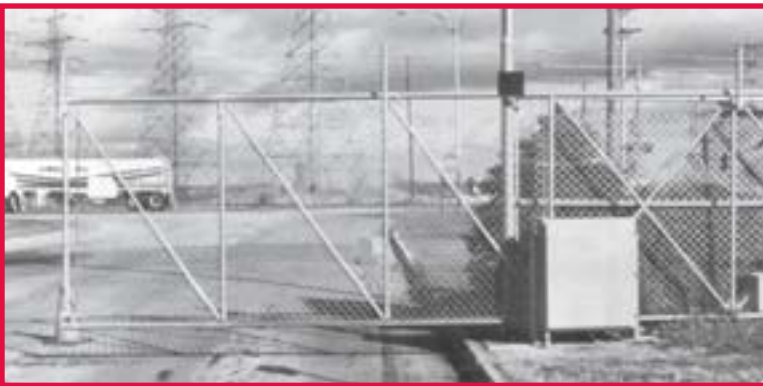

See page 4 for accessories

International Security Products recommends the use of an electric safety edge or photoelectric control for pedestrian protection on all automatic or remotely controlled gate or door operators

This gate operator can handle the **big jobs**.

Protects your security system at its most vulnerable point - the entry and exit opening.

The system includes

- Adjustable friction clutch
- All weather control panel
- Magnetic disc brake to prevent coasting of gate
- Available in all voltages and horsepower
- Manual disconnect in case of power failure
- Post or pad mounting
 - 3/4 hp for single gates up to 45' wide
Model HSLG-4
 - 3/4 hp for single gates up to 60' wide
Model GSLG-4

barrier arm gate operators

BGU Operator

The BGU model barrier gate operators are designed to control vehicular traffic and can be actuated by various devices, such as radio controls, digital keypads, vehicle sensing loop detectors and telephone entry systems. Gate cabinet has a powder coated finish and is weather-proof. 1/3hp.

*Includes: 3 button control station

BGU-10-10' L.Arm

BGU-12-12' L.Arm

BGU-14-14' L.Arm

BGU-16-16' L.Arm (Counter Balanced Arm)



SG-25 Operator

The SG-25 model barrier arm gate operators have a wishbone type counter balanced gate arm system that minimizes motor wear and maximizes operator duration. 14' to 25' long arm length is available. Weather-Proof cabinet. 1/3hp

*Includes: 3 button control station

SG Wishbone Arm Gate Operators
14' to 25' Long Arm

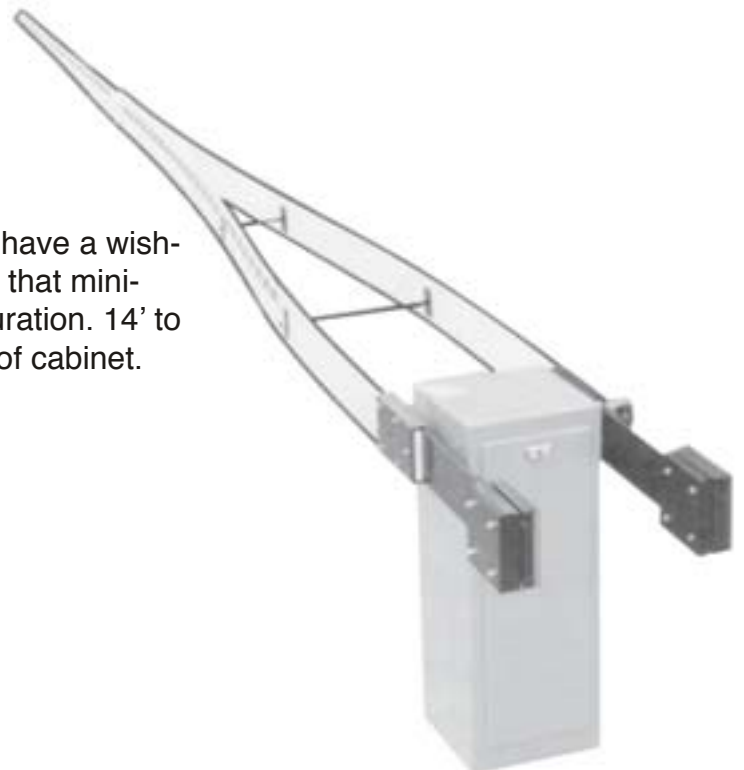

gate operator controls and accessories

Weathertight Controls

Frequently used where control stations are outside the fenced area

2520-137 Keyswitch for post mounting

2500-844 Keyswitch open-close-stop

2500-289 Keyswitch Heavy duty and tamper proof

Radio Controls

Used where operation is required from an automobile or a remote location

2520-054 Digital radio receiver

2500-303 Digital transmitter

2520-094 Long range receiver

2500-589 Long range transmitter

Card Reader Systems

Owner-programmable cards determine when and if access is allowed

2500-155 Programmable system

2500-128 Swipe reader

2120-035 Gooseneck stand

2500-109 Printer (for programmable system)

Photoelectric Controls

Used as a reversing or opening device with beam spanning gate opening

2520-031 Photoelectric unit 25' range

2520-032 Photoelectric unit 100' range

2120-038 Mounting pedestal (for Photoeye)

2120-039 Mounting pedestal (for Reflector)

Time Delay Systems

Used to close the gate after a preset time

2500-868 Digital timer to close

2500-046 Plug-in delay to close (0-1 minute)

2500-353 7-day timer

(holds preset time)

2520-153 Timer to close package (reversing edge, cord & timer)

Intercom System Complete

2520-053 Includes: Indoor and outdoor stations, 12 volt power supply, Gooseneck stand

Digital Keypad Entry Systems

An authorized person gains entry by keying in a valid five-digit code

2520-014 Digital pad, + gooseneck stand

2500-052 Digital keypad in enclosure

2500-035 Gooseneck stand

2500-129 Complete system

Programmable • 500 code capacity • time zone access

Card Controls

Standard non-programmable system

Gain entry by inserting a card

2520-011 Card reader, gooseneck stand

2520-027 Card reader, surface mount

2500-311 Card, standard (54 min., ea.)

Telephone Entry Systems

Provide person-to-person communications between the entrance and the dwelling

2500-1518 Residential entry system

(hands free)

2500-395 Multi-unit telephone entry

2500-441 Multi-unit with directory

2120-035 Gooseneck stand

Vehicle Loop Detector

Used to open gates, hold gates open and reverse gates from closing on vehicles

2510-013 Single detector, pre-wire

(in operator)

2510-014 2 detectors, prewired

2500-1447 Detector only, in operator

2510-015 Loop wire kit, including harness

Safety Gate Edge

Used to reverse gate upon contact with person or vehicle

2520-178 Electric gate edge

(w/ transmitter)

2500-307 Radio receiver (single channel)

2500-759 Radio receiver (two channel)

2500-760 Gate edge transmitter only

fortress and vertical pivot gates

Aluminum Square Frame Heavy Industrial Slide or Vertical Lift Gates



- Many Styles Available
- Single Slides – 6' to 60' openings
- Double Slides – 12' to 120' openings
- Rust Free – No Gate Sag
- Light Weight and Easy to Operate
- Enclosed Track System

• Fax or call in specifications for same day pricing.

Automatic Vertical Pivot Gates



- Radio Controlled
- Solar Powered or 110 AC
- 12 to 20 Feet Long
- Easy to Install
- Low Maintenance
- Up to 40 Feet with Double Gates

• Fax or call in specifications for same day pricing.

(800) 733-7422

commercial chain link gates

Commercial Double Drive Gates

International Security Products can provide any mesh size, pipe weight or gauge required to meet your specifications. Gates are of standard heavy duty 1-5/8" O.D. welded construction with 9 gauge galvanized 2" mesh.

See page 8 for gate hinges and hardware.

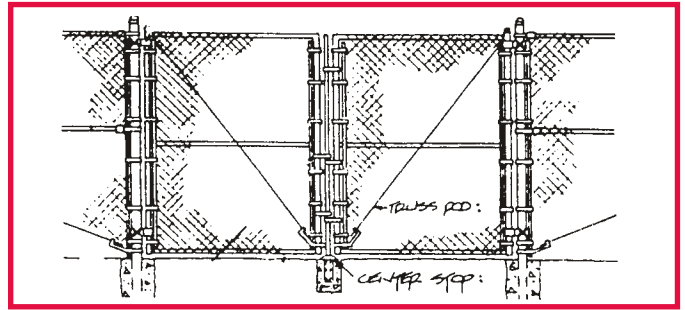

No.	Width/Height
IG126D1	12'x 6'
IG127D1	12'x 7'
IG128D1	12'x 8'
IG146D1	14'x 6'
IG147D1	14'x 7'
IG148D1	14'x 8'
IG166D1	16'x 6'
IG167D1	16'x 7'
IG168D1	16'x 8'
IG186D1	18'x 6'
IG187D1	18'x 7'
IG188D1	18'x 8'

No.	Width/Height
IG206D1	20'x 6'
IG207D1	20'x 7'
IG208D1	20'x 8'
IG226D1	22'x 6'
IG227D1	22'x 7'
IG228D1	22'x 8'
IG246D1	24'x 6'
IG247D1	24'x 7'
IG248D1	24'x 8'

Colored Gates Add 70%
2" Gate Frame- (Please inquire)

Commercial Walk Gates

International Security Products can provide any mesh size, pipe weight or gauge required to meet your specifications. Gates are of standard heavy duty 1-5/8" O.D. welded construction with 9 gauge galvanized 2" mesh.

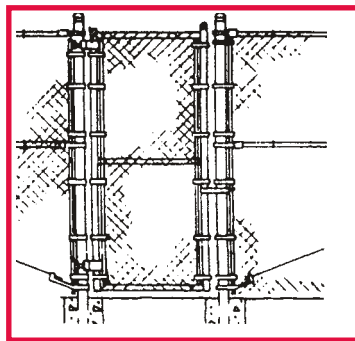

Colored Gates Add 70%
2" Gate Frame -Please inquire

See page 8 for gate hinges and hardware.

No.	Width/Height
IG3660S1	36"x 60"
IG3672S1	36"x 72"
IG3684S1	36"x 84"
IG3696S1	36"x 96"
IG4260S1	42"x 60"
IG4272S1	42"x 72"
IG4284S1	42"x 84"
IG4296S1	42"x 96"
IG4860S1	48"x 60"
IG4872S1	48"x 72"
IG4884S1	48"x 84"
IG4896S1	48"x 96"

International Security Products custom-makes every gate to your order. Please measure carefully since gates may not be returned nor the order cancelled. Gates are made to fit the opening between the posts

slide, barrier & folding gates

Cantilever Slide Gates

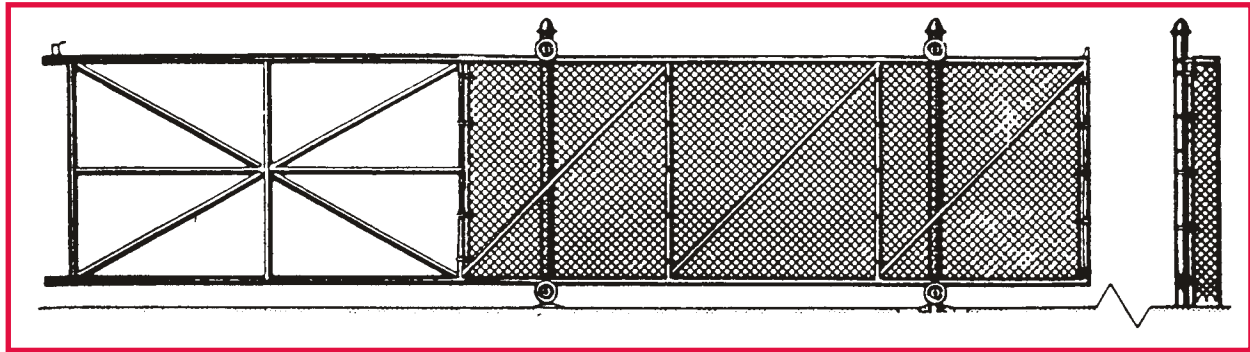

Space saving slide gates roll open on a track. Gates won't swing out and damage vehicles, property or the gate. Constructed of heavy-duty 9 gauge chain link mesh as the filler and 2-1/2" (O.D.) runners with 2" (O.D.) uprights.

Price per linear foot	Height	5'	6'	7'	8'
	with barbed wire				
Opening only	Gate size is measured by the opening between the posts				

Economical Barrier Gates

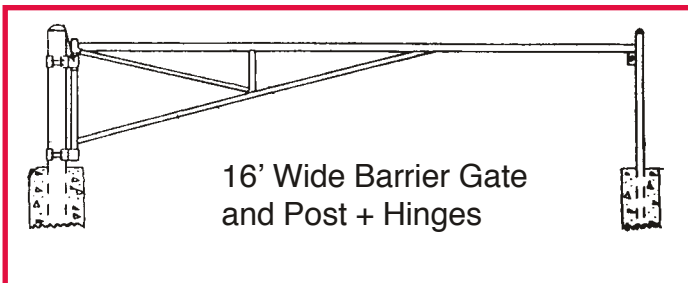

Gate only

Gate size is measured by the opening between the posts

Barrier gates keep a private driveway private or can be used to control entrance to a park, car lot or other places where restricted access is a priority.

Single or double barrier gates are available in 42" and 48" heights. Frame is 2" O.D. with 1-3/8" bracing. Welded construction.

- Single or double
- Specify opening size
- 2" O.D. frame 1-3/8" bracing
- Welded Construction
- PS20 Frame

Folding Scissor Gates



Installs quickly for additional security. Many styles available. Fax or call in for price quote.

(800) 733-7422

gate hinges and latches

Cantilever Rollers

Heavy-duty bearings for long life.

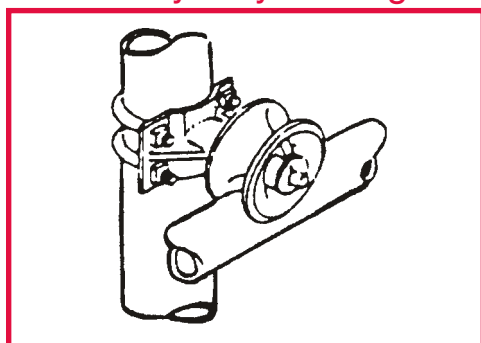

Cantilever rollers provide smooth operation for gates. Available for 3" and 4" gate posts.

4 rollers required per slide gate

3" gate post, 2-1/2" runner CR3

4" gate post, 2-1/2" runner CR4

Extra Heavy Duty Rollers

3" Gate Post, 2 1/2" runner CR3D

4" Gate Post, 2 1/2" runner CR4D

Slide Gate Gate Latch

Secure the slide gate with a padlock

CL2 2" Receiver

CL3 3" Latch

CL4 4" Latch

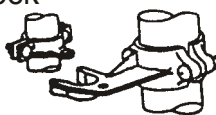

Cantilever Roller Guards

Adds safety and protects your rollers from debris

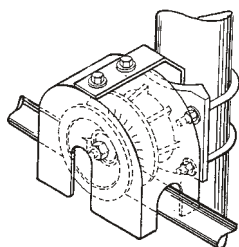

RG

per pair

Auto Latch & Closer

Spring-loaded latch makes it difficult for children to open gate. Ideal for swimming pools, playgrounds and day care centers.

AL2 2"x1-3/8"

AL25 2-1/2"x1-3/8"

Auto Closer Fits 2" or 2-1/2" post

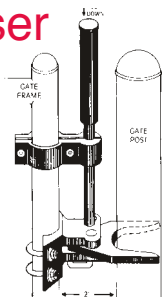

Hydraulic Gate and Door Closer

Effortless closing for large or small gates and doors

For chain link and wrought iron gates

Hydraulic system closes gently and smoothly. Self-closing feature ideal for pool gates.

Ends slamming and stops glass breakage plus energy loss.



KANT-SLAM
DOOR CHECK COMPANY

Installs quickly and easily **KANTSLAM**

Pressed Steel Industrial Hinge

Heavy Duty industrial hinge.

Installs easily

No.	Size
IH25B	2-1/2"x1-5/8"
IH3B	3"x1-5/8"
IH3B	3"x2"
IH4B	4"x1-5/8"
IH4B	4"x2"
IH6B	6-5/8"x1-5/8"
IH6B	6-5/8"x2"

Gate will open approximately 145° inside and outside.

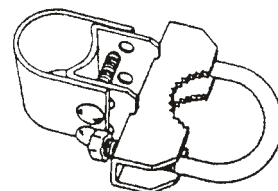

180° Industrial Hinge

Lets gate open parallel to the fence. Provides a wide opening for vehicles.

No.	Size
IH25180	2-1/2"x 1-5/8"
IH3180	3"x1-5/8"
IH4180	4"x1-5/8"
IH6180	6-5/8"x2"

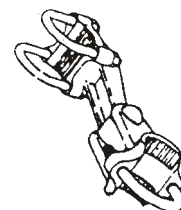

Fitting are measured by outside diameter

heavy duty gate latches

Industrial Double Drive Gate Latches

* New Tamper - Resistant Hardware *

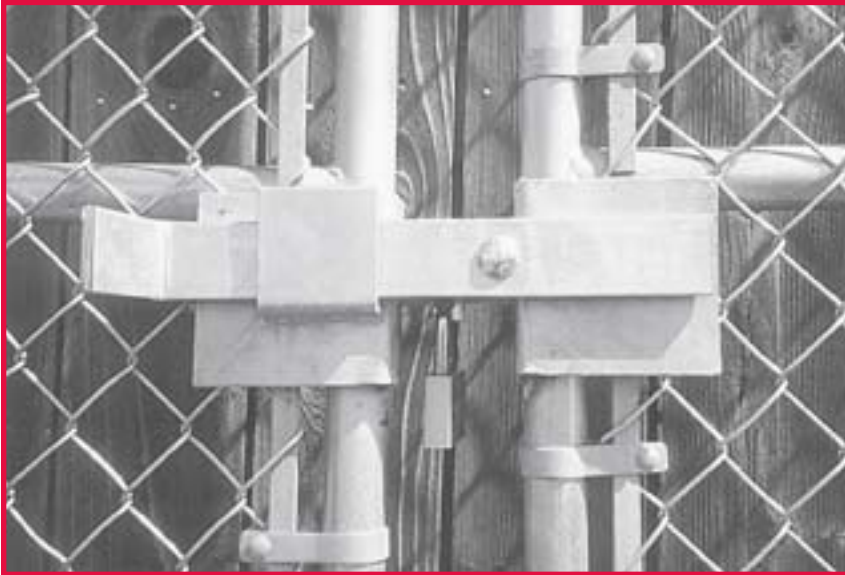

More secure than
gate chains

Heavy-duty hot-dipped galvanized steel construction secures a force of over 2,000 pounds. It's easy-to-use, so employees are more likely to lock the gate.

Fits double drive gates with an opening of 3-1/2" to 5-1/2" between gate leaves and 1-5/8" or 2" (O.D.) gate frames. Eliminates drop rod and center stop.

Easy to install PL152

Pre-Drilled to Bolt or Weld on to Gate Frame

Walk Gate Latch

Heavy-Duty Steel Construction

* New Tamper - Resistant Hardware *

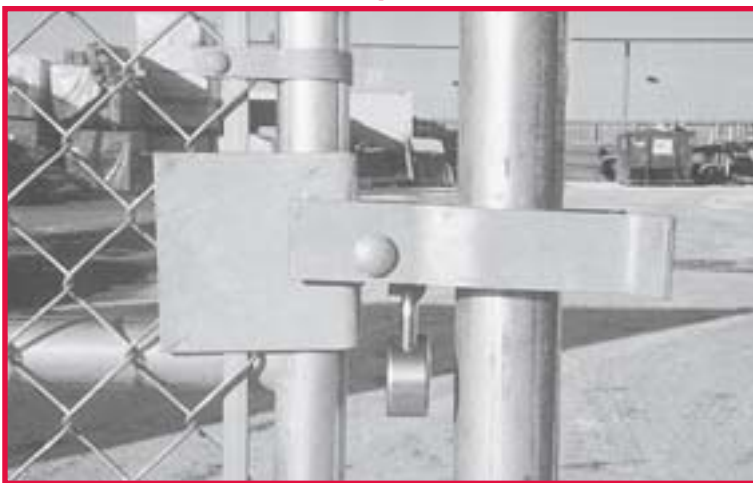

Hot-dipped galvanized steel construction. Secure to more than 2,000 pounds of force. Gate latch fits 1-5/8" or 2" (O.D.) gate frames.

Easy to use

Pre-Drilled

PL152W

All fence fittings fit over the outside of the fence pipe. (O.D.)

(800) 733-7422

full height turnstiles

The THT Turnstile series offers maximum security control at an affordable price.

Model THT-100C, 7' high Full Security Manual Turnstile, carbon steel construction, hot-dipped galvanized or primed, 3 rotor sections 120 degrees apart, one or two-way manual operation. (Pictured)

Model THT-100HGC, 7' high Full Security Handicap Turnstile, carbon steel construction, hot dipped galvanized, 47" arms for handicap access, one way or two way, 3 rotor sections 120 degrees apart.

Products include the following options:

- | | |
|-----------------------------|----------------------------|
| Handicap access | Coin or Token control |
| Four-arm | 3-arm, swipe card reader |
| Tandem | Mass transit |
| Clear Lexan | Portable 3-arm |
| Clear passage | Electronically controlled, |
| Elite Directional Commander | motorized gates |



Many styles and sizes are available. Call for more information and pricing.

Metal Detector Turnstile



THT-100 ASTMD

- Detector locks turnstile down and bars passage when set off.
- 2 Key operated modes of operation.
- Aluminum finish

Slide Gate Access



THG-51SGA

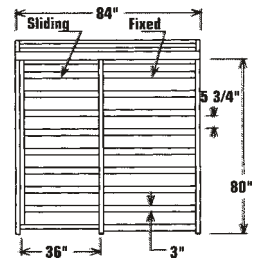

- For handicap personnel
- Fully compliant with ADA guidelines.
- 36" Clear opening
- Galvanized finish

waist-high turnstiles

Model
TUT-50R

- Mechanical
 - 5 Digit
Resettable
register
- Add:
For platform &
railing



Model
TUT-50NR

- Mechanical
- Basic
- Non- register



Model
TUT-50T

- Electric
- Coin/Token
operated
- 5 Digit
Resettable
register
- Built in
lockable coin
compartment

Model
TUT-60ES

- (pictured)
- Electric
 - Deluxe
 - Stainless
Steel
Cabinet



Model
TUT-60MC

- Deluxe
 - Portable
 - Mechanical
 - 5 Digit
Resettable
register
- Add:
For platform &
railing



residential ornamental fence systems

Pools • Real Estate Developments • Estates • Cemeteries • Beautification Projects

•Maintenance Free Perimeter Control•

Free
Quotation
and Design
Service



Fast And Easy
To Install

Standard
Colors:
Black
White
Bronze

Fully
Assembled
ALUMINUM

H	6' Panel	Corner Line - End Post/Cap	Walk Gates (width)			Double Drive Gates		Gate Post With Cap
			36"	48"	60"	10'	12'	
36"								
42"								
48"								
60"								
72"								

Style

ISP1

ISP1A

ISP2

ISP2A

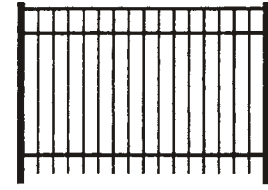
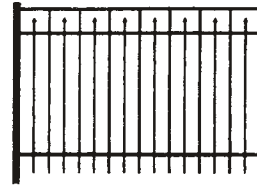
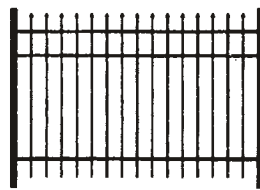
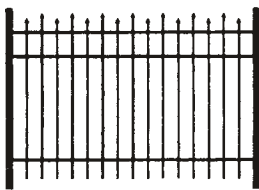

STEEL

H	8' Panel	Corner Line - End Post/Cap	Walk Gates (width)			Double Drive Gates		Gate Post With Cap
			36"	48"	60"	10'	12'	
36"								
42"								
48"								
60"								
72"								

Style

ISP-W

ISP-C

ISP-G

ISP-M

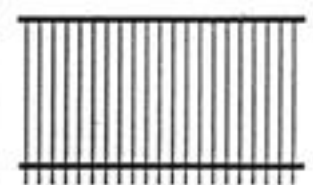
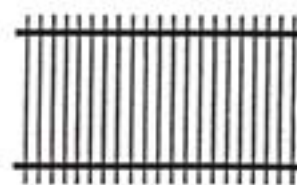
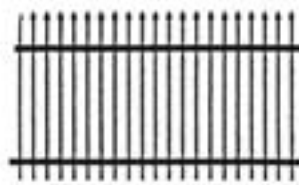
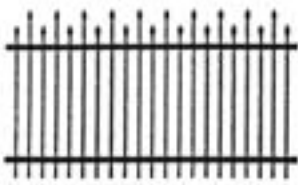

Gate framing matches cross-section of
fence horizontal rails.

The fencing systems are shipped in easy-to-assemble
components that can be easily transported to any
destination.

commercial ornamental fence systems

Pools • Real Estate Developments • Estates • Cemeteries • Beautification Projects
 •Maintenance Free Perimeter Control•

Free
Quotation
and Design
Service



Fast And Easy
To Install

Standard
Colors:
Black
White
Bronze

Fully
Assembled
ALUMINUM

H	6' Panel	Corner Line - End Post/Cap	Walk Gates (width)			Double Drive Gates		Gate Post With Cap
			36"	48"	60"	10'	12'	
48"								
60"								
72"								
96"								

Style

ISP1C

ISP1AC

ISP2C

ISP2AC

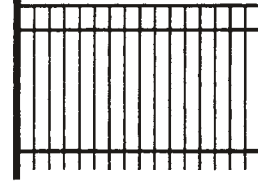
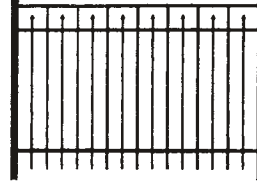
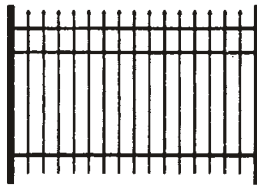
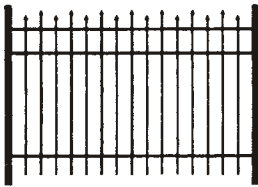

STEEL

H	8' Panel	Corner Line - End Post/Cap	Walk Gates (width)			Double Drive Gates		Gate Post With Cap
			42"	48"	60"	10'	12'	
48"								
60"								
72"								
84"								
96"								

Style

ISP-WC

ISP-CC

ISP-GC

ISP-MC

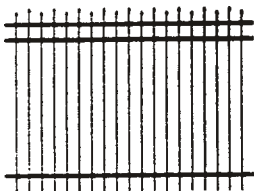

Gate framing matches cross-section of fence horizontal rails.

The fencing systems are shipped in easy-to-assemble components that can be easily transported to any destination.

(800) 733-7422

polyvinyl fence systems

This fence is so enduring it carries the industry's finest warranty. Modern polyvinyl compounds produce a bright white fence that never needs painting, won't chip, crack or peel and is impervious to weather and ultraviolet rays.

Maintenance Free Perimeter Control

Cost per Ft. includes: (1) section (1) Post and (1) post cap every 6 or 8 feet.

All Prices Are Per Linear Foot

Ask About Additional Styles and Colors

Heavy Rail Fence		
	Post	Per Foot
2-Rail	5"x 5"	
3-Rail	5"x 5"	
4-Rail	5"x 5"	



Picket Fence			GATE END CORNER
Height	6' Center	Post	
36"	15.15 FT.		
48"	17.38 FT.		
60"	19.54 FT.		



Scalloped Picket Style			GATE END CORNER
Height	6' Center	Post	
36"-42"	16.73 FT.		
48"-54"	19.25 FT.		
60"-66"	21.42 FT.		



Solid Privacy			GATE END CORNER
Height	8' Center	Post	
72"	16.10 FT.		
84"	34.10 FT.		
96"	37.30 FT.		



Slatted Privacy			GATE END CORNER
Height	8' Center	Post	
48"	17.29 FT.		
60"	21.94 FT.		
72"	25.15 FT.		



commercial chain link systems

Color Choices:
Green - Brown - Black
Posts, Top Rail and Fabric

**Fax Your
 Layout Sketch**

763-425-9006

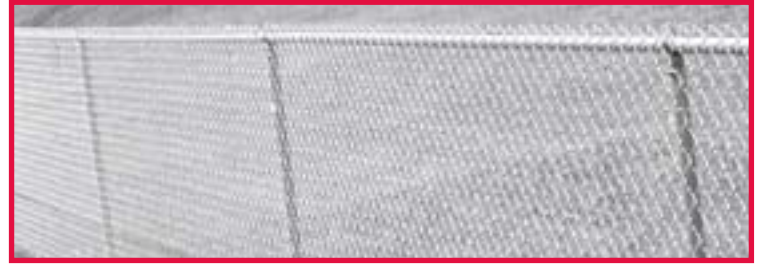

vinyl

8 Gauge vinyl coated fence fabric, 2" mesh
 1-5/8" O.D. PS20 colored top rail
 2" O.D. PS20 colored line post
 2-1/2" O.D. PS40 colored end, gate and corner post
 Post set 2' deep

48" fence, complete	per foot
2-1-2" end or gate post	each
2-1/2" corner post	each

60" fence, complete	per foot
2-1-2" end or gate post	each
2-1/2" corner post	each

72" fence, complete	per foot
2-1-2" end or gate post	each
2-1/2" corner post	each

84" fence, complete	per foot
2-1-2" end or gate post	each
2-1/2" corner post	each

96" fence, complete	per foot
2-1-2" end or gate post	each
2-1/2" corner post	each

The above prices are per linear foot of complete fence. This includes 9 line posts per 100 feet, tops, top rail, fence fabric and ties. End/gate and corner posts are complete except for hinges.

galvanized

9 Gauge galvanized fence fabric, 2" mesh
 1-5/8" O.D. PS20 galvanized top rail
 2" O.D. PS20 galvanized line post
 2-1/2" O.D. PS40 end, gate and corner post
 Post set 2' deep

48" fence, complete	per foot
2-1-2" end or gate post	each
2-1/2" corner post	each

60" fence, complete	per foot
2-1-2" end or gate post	each
2-1/2" corner post	each

72" fence, complete	per foot
2-1-2" end or gate post	each
2-1/2" corner post	each

84" fence, complete	per foot
2-1-2" end or gate post	each
2-1/2" corner post	each

96" fence, complete	per foot
2-1-2" end or gate post	each
2-1/2" corner post	each

The above prices are per foot of complete fence. This includes 9 line posts per 100 feet, tops, top rail, fence fabric and ties. End/gate and corner posts are complete except for hinges.

Volume Pricing & Free quotation available
All prices are I.S.P. Distribution Center plus freight
State and Federal specified materials available

See page 6 for gates

(800) 733-7422

sports fencing and netting

Golf Netting

Golf netting is fabricated from a minimum of #420 nylon fiber, 7/8" square mesh, weather treated in green or black knotted netting with a minimum break strength of 120 lbs per strand. All netting is bound with a 2" vinyl tape consisting of 13 ounce vinyl coated polyester fiber. Grommets at top, sides and bottom are at customer option. Hardware, including "S" hooks or snaps, are available.

Golf netting: 6' x 100' roll
8' x 100' roll

Baseball Netting

Baseball netting is fabricated from a minimum of #504 nylon fiber, 1-3/4" square mesh, weather treated in green or black knotted netting with a minimum break strength of 210 lbs per strand. All netting is bound with a 2" vinyl tape consisting of 13 ounce vinyl coated polyester fiber. Grommets at top, sides and bottom are at customer option. Hardware, including "S" hooks or snaps, are available.

Baseball netting: 6' x 100' roll
8' x 100' roll

★ Custom Sizes Available★

Tennis court fence 10' high, complete with 2 gates

9 Gauge Galvanized Wire Fabric, 2" mesh
1-5/8" O.D. Top Rail and Corner Bracing
2-1/2" O.D. Heavy Line Post
3" O.D. Corner Post
Complete color systems available

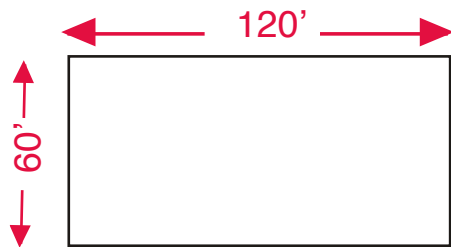

Single Court 60' x 120'

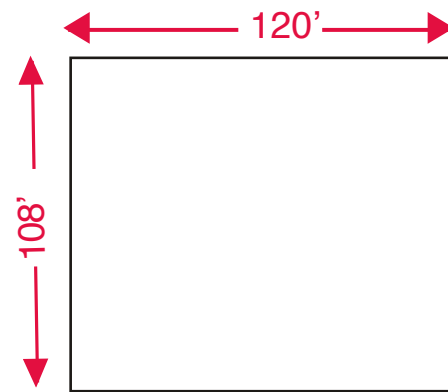
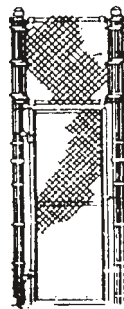

Double Court 108' x 120'

★ Tennis Court Accessories Available ★

Baseball Backstops • Batting Cages • Outfield Fences

9 Gauge Galvanized Wire Fabric, 2" mesh
1-5/8" O.D. Heavy Rails
3" O.D. Heavy Post.

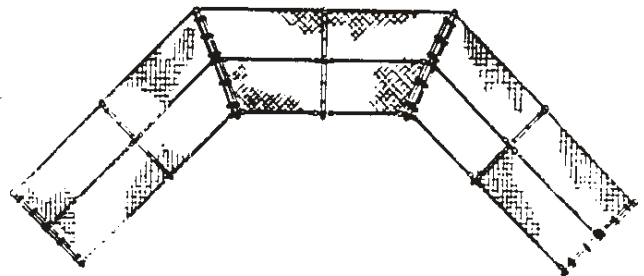
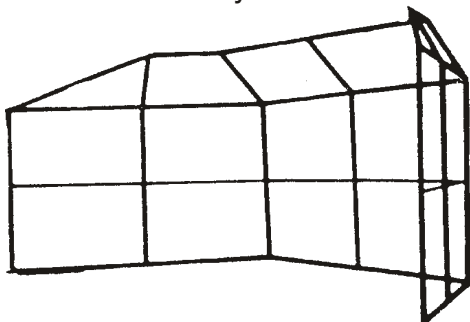

BB10 20' Back/ 10' Wings/ 10' High
BB11 30' Back/ 10' Wings/ 10' High
BB12 6' Overhang (for above)

Inquire for different heights, configurations and weights of materials

fence guards and tools

Fence Guards

Protects against chain link fence injuries on ball fields, playgrounds, parks, schools and homes.

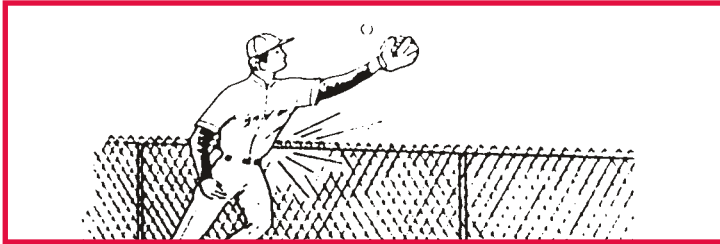

104' Per Package = 13 pcs. @ 8' Long

Fence Guard is the most up-to-date protection against serious injuries from chain link fences



Easy to install on to top rail, covering barbs or knuckles of fence fabric.

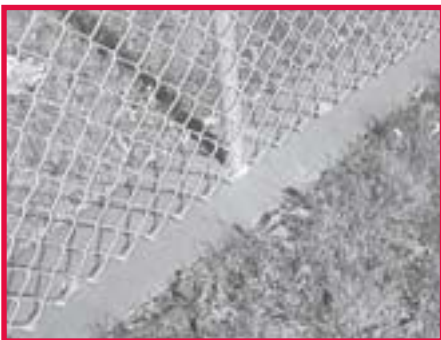

Trim Saver

- Eliminates hand trimming
- per foot
- 8" wide
- Can be installed under existing fence
- Easy to install

★ Save Time and Money ★

Fence Tools

Fence Pliers

- PL10 10" Pliers (Utica Style)
- PLH Hog Ring Pliers

Gate Clipping Tools

- FET Fence Stretching Frame
- CLT Clipping Tool

Wire Grip

- Grip Tension & Barb Wire

Pulls and Stretchers

- Pull Maasdam Power Pull
- Stret Panel Stretcher
- Jack Stretcher

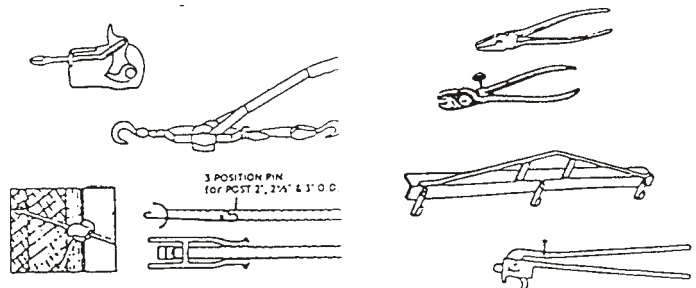

(800) 733-7422

galvanized pipe and posts

Sign posts, fence posts, greenhouses, boat dock posts, fence top rail, heavy fence posts, bumper posts, tennis net posts, industrial applications and fence bottom rail.

Flanged Posts Available For Commercial Inside Jobs.

One Piece to Full Truckloads

PS20 Structural Post

Model	Size	(ea.)	Model	Size	(ea.)
PS226	2" O.D.X 6'		PS2256	2-1/2" O.D.X 6'	
PS227	2" O.D.X 7'		PS2257	2-1/2" O.D.X 7'	
PS228	2" O.D.X 8'		PS2258	2-1/2" O.D.X 8'	
PS229	2" O.D.X 9'		PS2259	2-1/2" O.D.X 9'	
PS2210	2" O.D.X 10'		PS22510	2-1/2" O.D.X 10'	

PS40 Structural Post

Model	Size	(ea.)	Model	Size	(ea.)
PS426	2" O.D.X 6'		PS4256	2-1/2" O.D.X 6'	
PS427	2" O.D.X 7'		PS4257	2-1/2" O.D.X 7'	
PS428	2" O.D.X 8'		PS4258	2-1/2" O.D.X 8'	
PS429	2" O.D.X 9'		PS4259	2-1/2" O.D.X 9'	
PS4210	2" O.D.X 10'		PS42510	2-1/2" O.D.X 10'	
PS437	3" O.D.X 7'		PS447	4" O.D.X 7'	
PS438	3" O.D.X 8'		PS448	4" O.D.X 8'	
PS439	3" O.D.X 9'		PS449	4" O.D.X 9'	
PS4310	3" O.D.X 10'		PS4410	4" O.D.X 10'	
PS4311	3" O.D.X 11'		PS4411	4" O.D.X 11'	

Galvanized Fence Top Rail and Pipe

Model	Size	Weight (per ft.)	Model	Size	Weight (per ft.)
T156521S	1-5/8" O.D.X 21'	.065	T256521	2-1/2" O.D.X 21'	.065
PS21521S	1-5/8" O.D.X 21'	PS20	PS22521	2-1/2" O.D.X 21'	PS20
PS41521	1-5/8" O.D.X 21'	PS40	PS42521	2-1/2" O.D.X 21'	PS40
T26521	2" O.D.X 21'	.065	PS2321	3" O.D.X 21'	PS20
PS2221	2" O.D.X 21'	PS20	PS4321	3" O.D.X 21'	PS40
PS4221	2" O.D.X 21'	PS40	PS4421	4" O.D.X 21'	PS40
			ST621	6-5/8" O.D.X 21'	ST40

Additional sizes and lengths available

galvanized fence fittings

Tension Bands

Connects tension bars to post

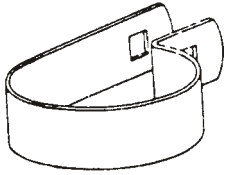

TBL13	1-3/8" O.D.
TBL15	1-5/8" O.D.
TBL2	2" O.D.
TBL25	2-1/2" O.D.
TBL3	3" O.D.
TBM4	4" O.D.
TBM6	6-5/8" O.D.

Brace Bands

Connects rail ends to a post

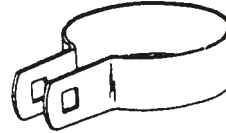

BBL13	1 3/8" O.D.
BBL15	1-5/8" O.D.
BBL2	2" O.D.
BBL25	2-1/2" O.D.
BBL3	3" O.D.
BBM4	4" O.D.
BBM6	6-5/8" O.D.

Line Rail Clamps

Connects bottom rail to line post

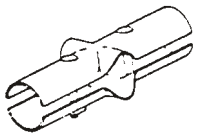

LRC1313	1-3/8" x 1-3/8"
LRC1515	1-5/8" x 1-5/8"
LRC215	2" x 1-5/8"
LRC2515	2-1/2" x 1-5/8"
LRC315	3" x 1-5/8"

Rail Ends

Steel (commercial)

Connects top rail to post



RES15	1-5/8" O.D.
RES152	1-5/8" O.D. (2 Hole)
RES2	2" O.D.

Tension Bars Light — 5/8"

Connects the mesh to the post



BARL36	36"
BARL42	42"
BARL48	48"
BARL60	60"
BARL72	72"

Tension Bars Heavy — 3/4"

Connects the mesh to the post



BARM48	48"
BARM60	60"
BARM72	72"
BARM84	84"
BARM96	96"
BARM120	120"
BARM144	144"

Truss Rod

For bracing corners and gates

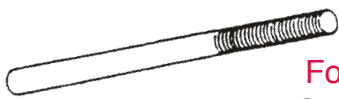

ROD11	11' Rod
-------	---------

Outside Rail Sleeve

Connects commercial top rail

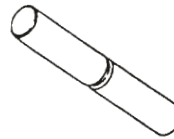

RS13	1-3/8"
RS156	1-5/8"
RS27	2"

Truss Rod Tightener

For tightening the truss rod

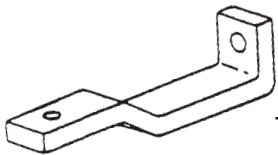

TT

Pipe Plugs

Steel

Plugs post and rail ends



PP13	1-3/8"
PP15	1-5/8"
PP2	2"
PP25	2-1/2"

Fence Tie Wires

Aluminum cut ties

Used to tie fence fabric to top rail and line post



CT116	11 GA. 6-1/4"
CT96	9 GA. 6-1/4"
CT98	9 GA. 8-1/4"
CT66	6 GA. 6-1/4"
CT68	6 GA. 8-1/4"

Per 100

100 Per Package

All fence fittings are O.D. dimension
Order nuts and bolts separately

galvanized fence fittings & misc.

barbed tape

Post Cap

Steel (commercial)

Fits on top of corner and gate post



DTS2	2" O.D.
DTS25	2-1/2" O.D.
DTS3	3" O.D.
DTS35	3-1/2" O.D.
DTS4	4" O.D.
DTS6	6-5/8" O.D.

Loop Top

Steel (commercial)

Fits on top

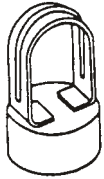

LTS15	1-5/8"x 1-5/8"
LTS2	2"x 1-5/8"
LTS25	2-1/2"x 1-5/8"
LTS3	3"x 1-5/8"

Barbed Wire Y-Arm

Fits on line post - holds 6 strands of barbed wire

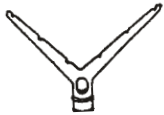

BWA62	2"x 1-5/8"
BWA625	2-1/2"x 1-5/8"

Barbed Wire Arm 45°

Holds top rail on line post and 3 strands of barbed wire. (Vertical arms also available)



BWA4515	1-5/8"x 1-5/8"
BWA452	2"x 1-5/8"
BWA4525	2-1/2"x 1-5/8"
BWA45HC	H STD "C"

Barbed Wire Corner Arms

Holds barbed wire on corner post

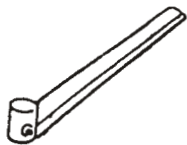

BWAC25M	2-1/2"
BWAC3M	3"
BWAC4M	4"

Barbed Wire



BW412	4PT. Galvanized 1,320' Roll
BW412A	4PT. Aluminized 1,320' Roll

Type 1

The name that made barbed tape famous. Helical coils are usually with two points of attachment, one at fence fabric and another at top strand of barbwire to prevent spreading of loops.

Type	Dia.	Coverage
BT18	18"	50ft
BT24	24"	50ft



Type 2

The largest selling correctional use barrier is constructed from the flanged, reinforced cross section and is clipped together at 5 locations about the circumference. Available in galvanized or stainless steel.

Type	Dia.	Coverage
SM30	30"	25ft
SM36	36"	25ft



Type 3

High strength spring quality stainless steel with offset bars and psychological deterrence makes it one of the neatest looking barriers when installed.

Type	Dia.	Coverage
IB24	24"	50ft
IB30	30"	50ft
IB40	40"	50ft
IB60	60"	50ft



Type 4

High strength spring quality stainless steel with offset bars and psychological deterrence makes it one of the neatest looking barriers when installed.

Type	Dia.	Coverage
NB36	36"	25ft
NB40	40"	25ft
NB60	60"	25ft



Other types of barbed tape available - Please inquire

chain link privacy materials

Standard – Colored Vinyl Fence Inserts

Cape Cod Grey, Desert Beige, Redwood, Hedge Green, Snow White, Rustic Brown, Sky Blue and Black

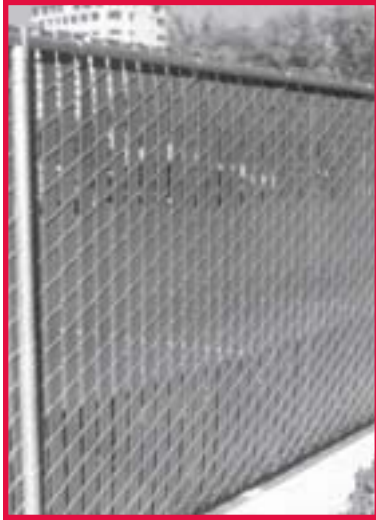

**Easy
To
Install**

Type	Height
PDS48	4'
PDS60	5'
PDS72	6'
PDS84	7'
PDS96	8'
PDS5	Bottom Channel

Specify Color

Packaged in plastic bags. 10' per bag, including 2-5' lengths of channel, 8.5 slats per foot (85 slats per bag). Additional channel available in 5' lengths. **SOLD IN FULL BAGS ONLY.**

Winged – Plastic Filler Strips

OFFERS 98% Opacity

New EZ Install Winged Filler Strips

White, Green, Brown, Tan, Redwood, Grey, Black and Light Blue

An exclusive one piece combination of rigid and flexible plastics for durability and the quickest, easiest installation possible- no locking channel needed.

(winged) (standard)

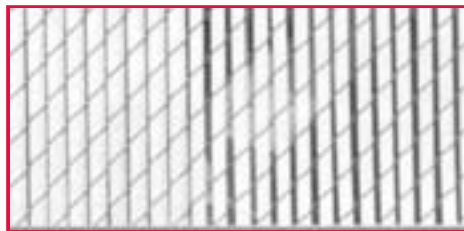

Type	Height
PDS48W	4'
PDS60W	5'
PDS72W	6'
PDS84W	7'
PDS96W	8'

Aluminum Filler Strips

Mint Green, White, Aqua, Cascade Blue, Antique Yellow, Redwood, Chinese Red, Forest Green, Sandlewood, Black, Orange and Brown

Type	Fence Height	Picket Length	
FS4	4'	62"	Per 100
FS5	5'	77"	Per 100
FS6	6'	92-3/8"	Per 100
FS7	7'	102-3/4"	Per 100
FS8	8'	122-3/4"	Per 100

**Greatest Privacy From
Diagonal Filler Strips**



100 pieces with 1 in 5 pattern covers 20'

SPECIFY COLOR

1-7/8" Strip furnished for all fences. Because of variation in diagonal lengths of different manufactures, we suggest you measure the length of strip needed. The next stock length will be charged for lengths other than our stock lengths.

modular interior and exterior structures

Reusable Steel Modular Buildings

Assembled from patented pre-framed panels; pre-engineered for easy relocation.
Bolt together assembly – Fast and easy to install.

- Many sizes available
- Temporary fabrication shops
- Temporary job site storage for crafts or sub-contractors
- Temporary change, break and lunch rooms
- Temporary project management offices
- Temporary maintenance enclosures for control work area environments and more
- Reconfiguration
- Has a definite re-sale value

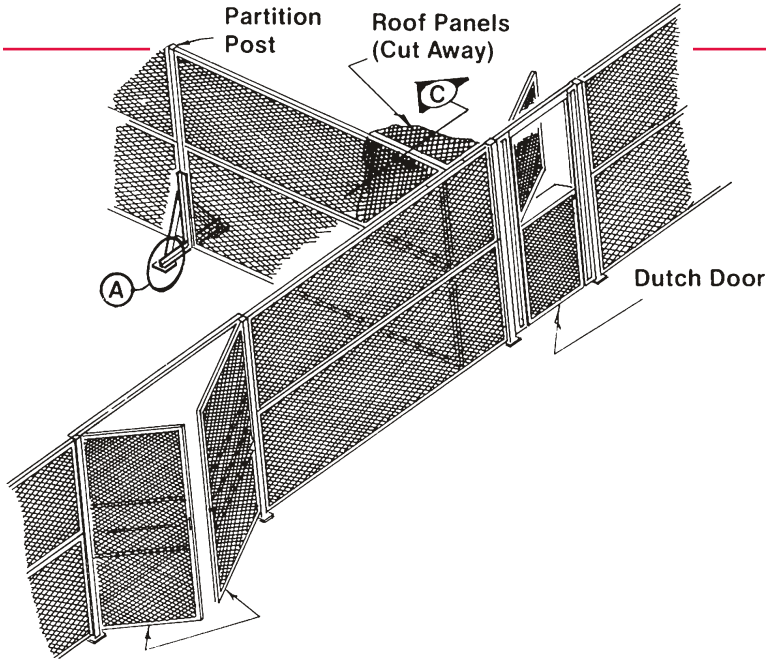

8' wide x 8' high
Swinging Door

Reusable Expanded Metal Pre-Framed Modular Panels

See-through interior enclosures for:

- Tool cribs
- Access control partitions
- Security cages
- Secure see-through partitions
- Quick and very simple to set up
- Quick disassembly and easy reuse options
- Versatile reconfiguration options
- Many sizes available

Woven Wire Partitions

Woven wire partitions can be used in a wide variety of applications such as, warehouse separation, Storage Lockers, and Secured areas.

Sturdy and easy to install Pre-built panels.

FAX OR CALL IN DIMENSIONS FOR PRICE QUOTE.

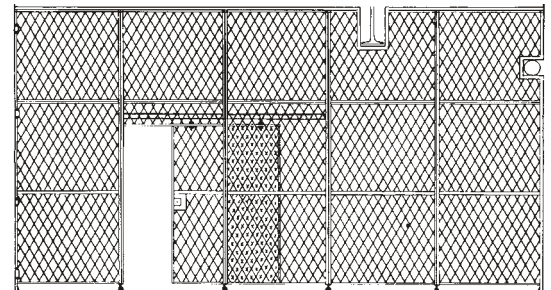

barriers and specialty fences

Steel Barriers

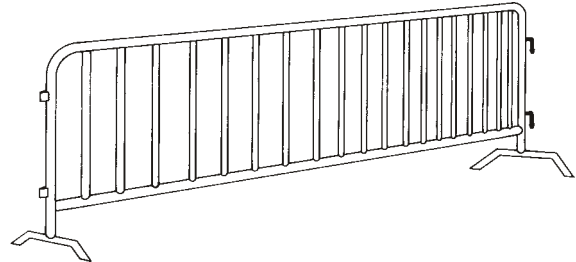
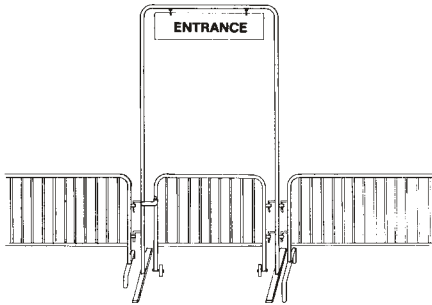

Portable galvanized steel barriers are ideal for temporary perimeter fencing, crowd control, police barriers, routing vehicular or foot traffic and many other versatile applications.

8' Long - 43" High - Interlocking panels.

Fax or Call for price quote based on quantity.

Vinyl Specialty Fences

Construction Size Color Weight



48"x50' Orange #16
 48"x100' Orange #32
 60"x50' Orange #19
 72"x50' Orange #22

Ranch Size Color Weight

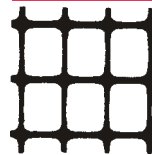

24"x100' Black #21
 48"x100' Black #42
 48"x100' Black #37
 48"x100' Black #42

Safety Size Color Weight



48"x50' Orange #8
 48"x100' Orange #17
 72"x50' Orange #33



48"x100' Orange #25
 48"x100' Black #25

Privacy Shade Screen

Type	Color	Size
DG56	Dark Green	56"x 150'
DG68	Dark Green	68"x 150'
DG80	Dark Green	80"x 150'
DG92	Dark Green	92"x 150'

System Ties and Posts

7"x1000/per case	Black	#4
11"x1000/per case	Black	#5

brick pillar kits

Easy To Assemble Do-It-Yourself Kits



- * All Costs are Per Pillar Kit
- * Minimum Order = 2 Kits
- * Cost Does Not Include Freight
- * Other Heights and Styles Available
- * **CALL FOR FREE BROCHURE**



Peaked Cap
13" Sq. - 17" Sq.

Flat Cap
13" Sq. - 17" Sq.

- 4' -
- 5' -
- 6' -
- 7' -
- 8' -
- 9' -
- 10' -

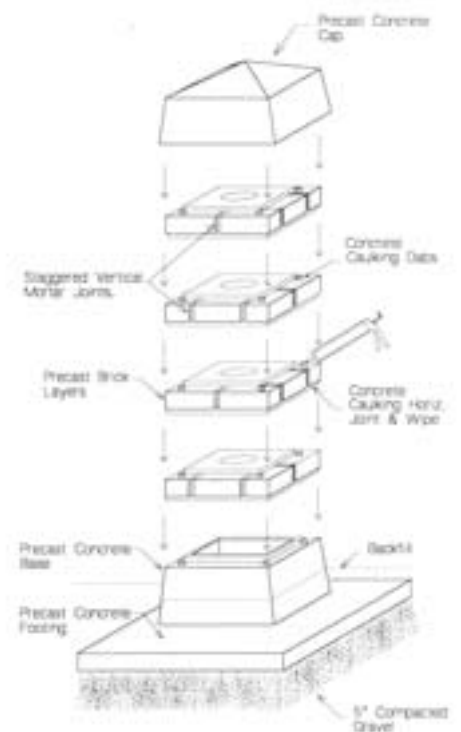

INDEX

Barb Wire and Barbed Tape	Page 20	Gate Operator Controls / Accessories	Page 4
Barrier Arm Gate Operators	Page 3	Modular Int. and Ext. Structures	Page 22
Barriers and Specialty Fences	Page 23	Netting Products - Baseball / Golf	Page 16
Brick Pillar Kits	Page 24	Ornamental Steel and Alum. Fence	Page 12/13
Chain Link Privacy Materials	Page 21/23	PVC / Polyvinyl Fence Systems	Page 14
Commercial Chain Link Gates	Page 6	Residential Ornamental Fence	Page 12
Commercial Chain Link Systems	Page 15	Slide, Barrier and Folding Gates	Page 7
Commercial Ornamental Fence	Page 13	Slide Gate Operators	Page 2
Fence Guards and Fence Tools	Page 17	Sports Fencing - Backstops /Outfield	Page 16/17
Fortress and Vertical Pivot Gates	Page 5	Swing Gate Operators	Page 1
Galvanized Fence Fittings ... Misc.	Page 19/20	Turnstiles - Full Height	Page 10
Galvanized Pipe and Posts	Page 18	Turnstiles - Waist High	Page 11
Gate Hinges and Latches	Page 8	Vinyl Coated Chain Link Systems	Page 15
Gate Latches - Heavy Duty Commercial	Page 9	Vinyl Specialty Fences	Page 23

ORDERING INFORMATION

ORDERING

The Fax is **FASTEST**. 24 hours every day of the week. Fax: (763) 425-9006. Or call Toll Free (800) 733-7422 to place your order.

TERMS AND CONDITIONS

Visa, Master Card and Discover accepted. Only cashier's or certified checks accepted. If an open account is desired, please call for a credit application. Allow ten days for processing. **All government, utilities and large national corporation orders will be shipped upon receipt of a valid purchase order.** All prices are subject to change.

MINIMUM ORDER

Any order totaling less than \$25.00 is subject to a \$5.00 handling charge.

LATE PAYMENT OR BAD CHECKS

Interest charges at the rate of 1.8% per month will be added to all accounts unpaid past the terms of the agreement. Accounts with past due balances will be shipped C.O.D. A minimum \$25.00 fee will be charged for any returned checks.

SHIPPING

Products are priced from the distribution center nearest to the delivery site. All material is shipped freight collect unless otherwise requested. A special handling charge of \$8.00 plus shipping cost will be added to all United Parcel shipments.

DAMAGES AND SHORTAGES

All shortage claims must be filed within three (3) days of receipt of material. Materials are F.O.B. our distribution center. Title is transferred to the carrier when material is picked up. Claims for shortages or damaged material must be made by the purchaser directly to the carrier.

WARRANTY POLICY

International Security Products warrants that its products are designed to meet quality standards and hereby certifies that its products are free from defects in both material and manufacturing.



Your One – Stop Source For:

- ◆ Automatic Gate Operators
- ◆ Barrier Arm Gates
- ◆ Turnstiles & Lift Gates
- ◆ P.V.C. Rail and Privacy Fence
- ◆ Ornamental - Aluminum and Steel Fencing
- ◆ Athletic and Recreational Fence Systems
- ◆ Chain Link Fencing / Custom Gates



Minneapolis Headquarters

Special Values

- **Modular Interior and Exterior Structures**
See Page 22
- **Heavy Duty Industrial Gate Latches**
See Page 9
- **Commercial & Residential Ornamental Fence**
See Page 12 & 13
- **Chain Link Fence Guards and Trim Saver**
See Page 17
- **Brick Pillar Kits**
Easy Assembly!
See Page 24

1-800-733-7422

www.ispfence.com

International Security Products

8511 Xylon Avenue North
Minneapolis, MN 55445-1820

PRSR STD
U.S. POSTAGE
PAID
Permit No. 225
Osseo MN

